

M12 MALE 0° / M12 FEMALE 0°

PUR 4X0.75 GRAY, UL/CSA 2.5m

Male straight – female straight

M12 – M12, 4-pole

Art-No. 7005 - M12 Lite - (plastic hexagonal screw) on request

Plastic housings with good resistance against chemicals and oils.

The resistance to aggressive media should be individually tested for your application. Further details on request.

Further cable lengths on request.

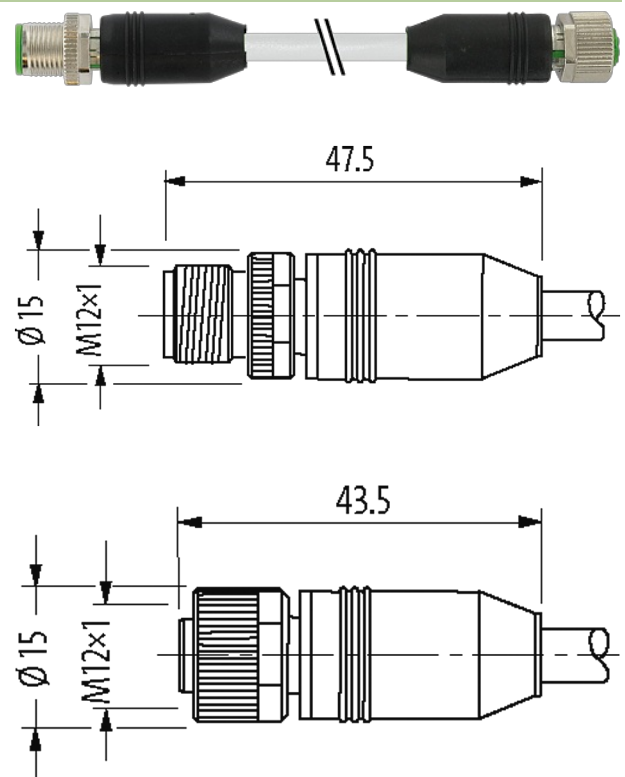
Link to Product**Illustration**

Product may differ from Image

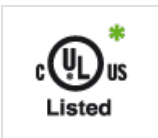
Approvals

* only for products with UL/CSA approved cable

Form

Form 40021

General data

Temperature range -25...+85 °C, depending on cable quality

CablesNo./diameter of wires 4 x 0.75 mm²

Wire isolation PP (br, wh, bl, bk)

C-track properties	10 Mio.
Material (jacket)	PUR (UL/CSA)
Outer Ø	6.5 mm ±5%
Bend radius (moving)	10× outer Ø
Temperature range (fixed)	-40...+80 °C
Temperature range (mobile)	-25...+80 °C
Cable identification	862
Cable Type	3 (PUR)
Approval (cable)	cURus (AWM-Style 20549/10493); CE conform
Cable weight [g/m]	67,10
Material (wire)	Cu wire, bare
Resistor (core)	max. 26 Ω/km (20 °C)
Single wire Ø (core)	0.15 mm
Construction (core)	42× 0.15 mm (multi-strand wire class 6)
Diameter (core)	4× 0.75 mm ²
AWG	similar to AWG 18
Material (wire isolation)	PP
Material property (wire isolation)	CFC-, halogen-, cadmium-, silicone- and lead-free
Shore hardness (wire isolation)	70 ±5 D
Wire-Ø incl. isolation	1.85 mm ±5%
Color/numbering of wires	br, bk, bl, wh
Stranding combination	4 wires twisted
Shield	no
Material (jacket)	PUR
Material property (jacket)	CFC-, halogen-, cadmium-, silicone- and lead-free, matt, low-adhesion, machine easy to process, abrasion-resistant, hydrolysis and microbial resistant
Shore hardness (jacket)	90 ±5 A
Outer-Ø (jacket)	6.5 mm ±5%
Color (jacket)	gray
chemical resistance	good resistance to oil, gasoline and chemicals (EN 60811-404)
thermal resistance	flame retardant UL 1581 VW1 / CSA FT1 / IEC 60332-1, IEC 60332-2-2
Nominal voltage	300 V AC
Test voltage	2500 V AC
Current load capacity	to DIN VDE 0298-4
Temperature range (fixed)	-40...+80 °C, (+90 °C at max. 10 000 operating hours)
Temperature range (mobile)	-25...+80 °C, (+90 °C at max. 10 000 operating hours)
Bend radius (fixed)	5× outer Ø
Bend radius (moving)	10× outer Ø
No. of bending cycles (C-track)	max. 10 Mio. (25 °C)
Travel speed (C-track)	max. 3 m/s
Acceleration (C-track)	max. 10 m/s ²
Torsion stress	±180°/m
No. of torsion cycles	max. 2 Mio. (25 °C)
Torsion speed	35 cycles/min
Jacket Color	gray
Technical Data	
Operating voltage	max. 250 V AC/DC
Operating voltage (only UL listed)	max. 30 V AC/DC
Operating current per contact	max. 4 A

Locking of ports	Screw thread (M12×1 mm) recommended torque 0.6 Nm, self-securing
Locking material	Zinc die casting, matte nickel plated
Protection	IP66K, IP67 inserted and tightened (EN 60529)

Commercial data

country of origin	DE
customs tariff number	85444290
EAN	4048879183123
eClass	27279218
Packaging unit	1

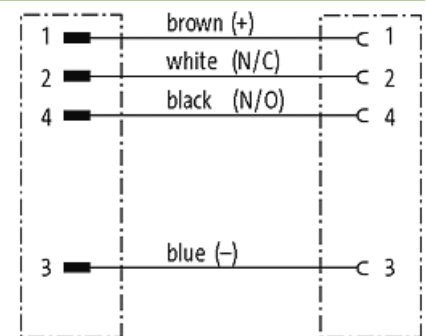
Sketch

Male

Female

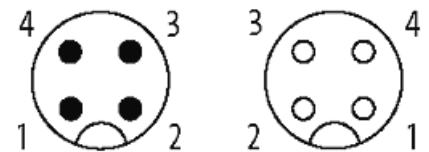

Product may differ from Image